

Cabinet airtight skirts

Tools

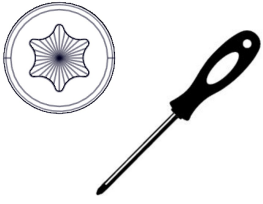

T25

Components

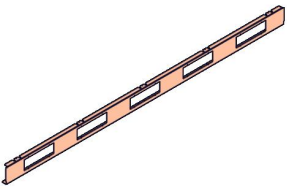

1000T

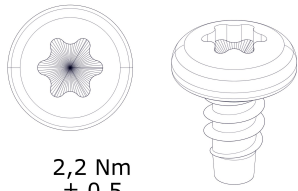

2,2 Nm
 $\pm 0,5$

ST 4,2 x 8 (T25)

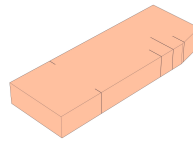

100MP



X00MA

1.1

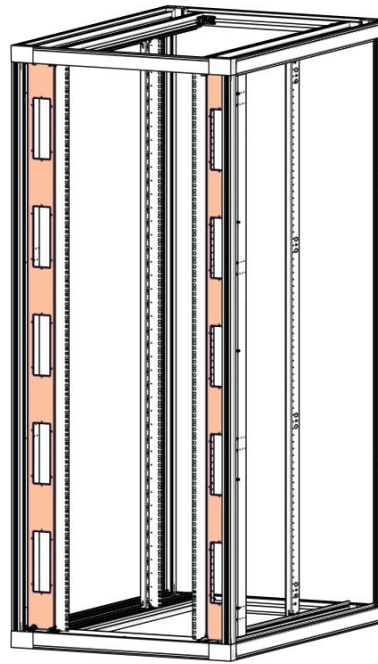
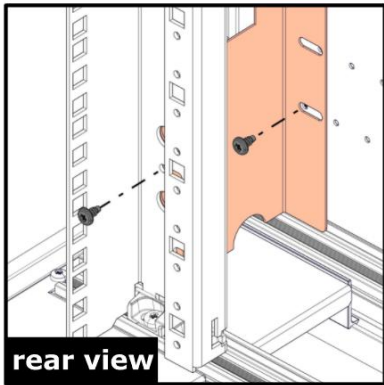
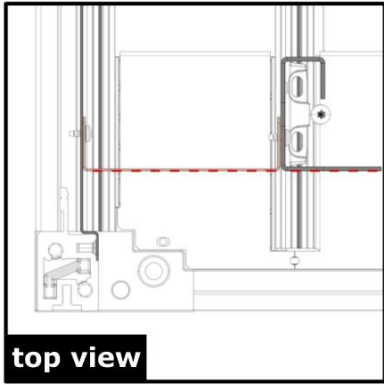

POSITION A
 ≥70 mm from front

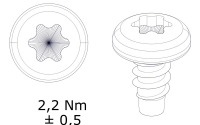
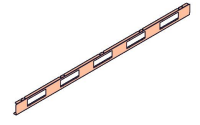

ST 4,2 x 8 (T25)



N-000015-1/000871-3

1.2

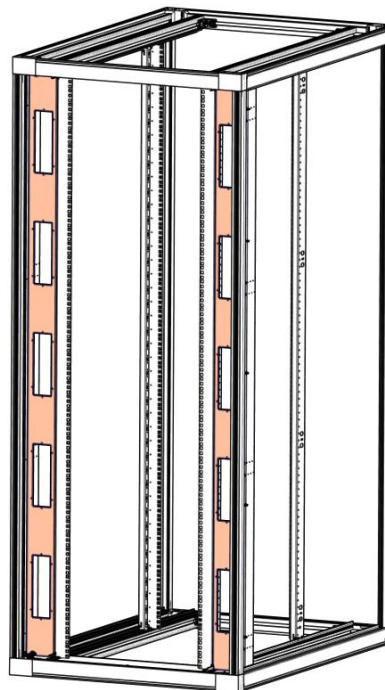
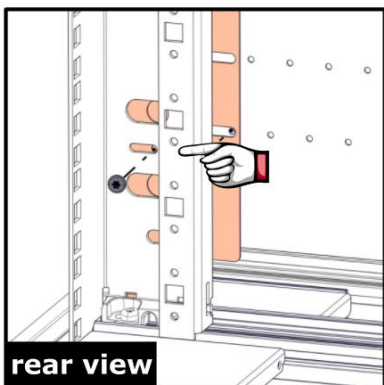
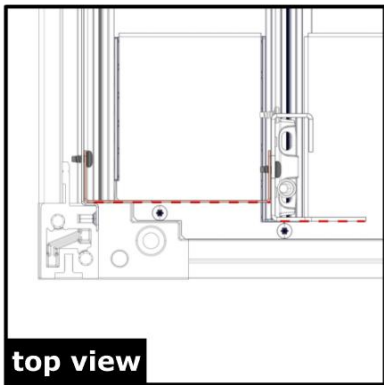

POSITION B
 60 mm from front
Optional

N-000015-1/000871-3

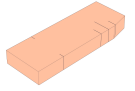
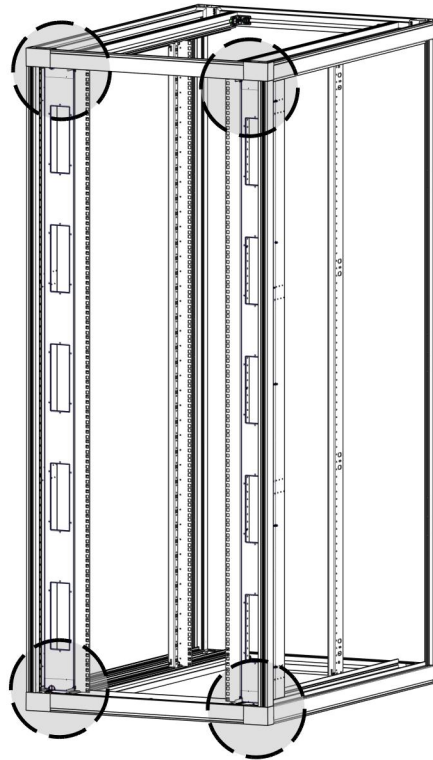
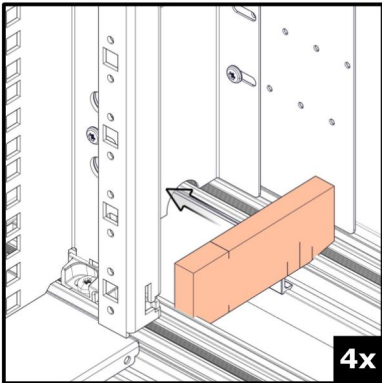
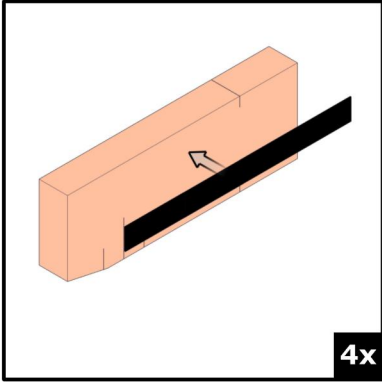

100MP



X00MA

N-000015-1/000871-3

