

Corridor cable bridge

Tools

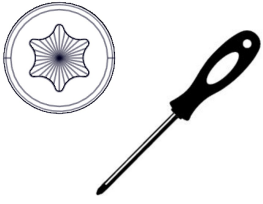

T25

Components

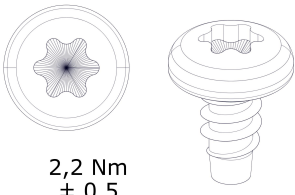

2,2 Nm
 $\pm 0,5$

ST 4,2 x 8 (T25)

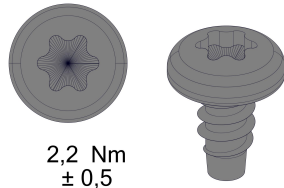

2,2 Nm
 $\pm 0,5$

ST 4,8 x 8 (T25)

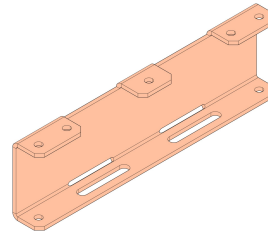

101HC

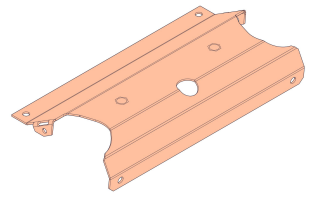

101HE

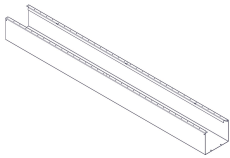

101HF

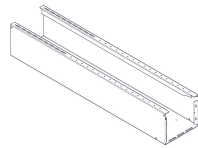

101HH

1.1

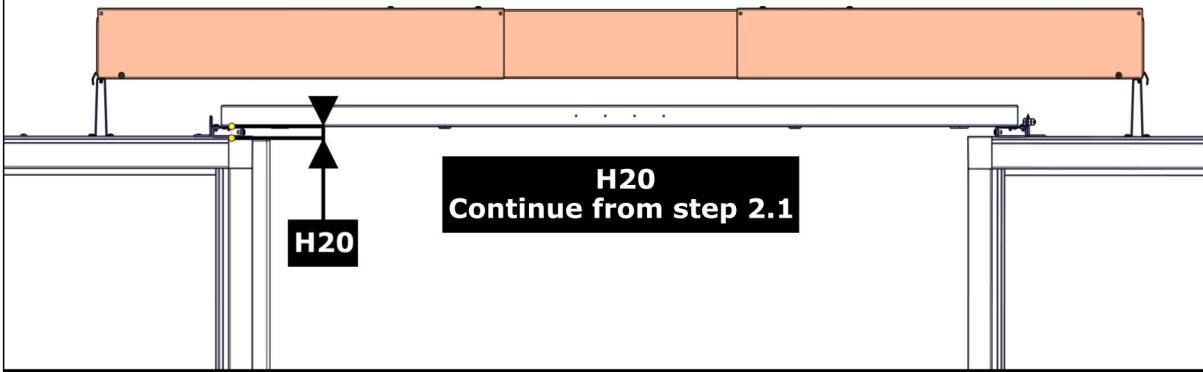

H100
Continue from step 3.1

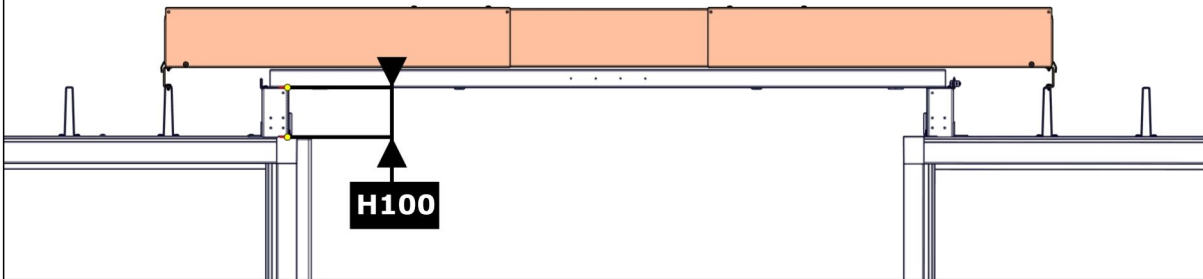

N-000105-0/001200-0

2.1

H20

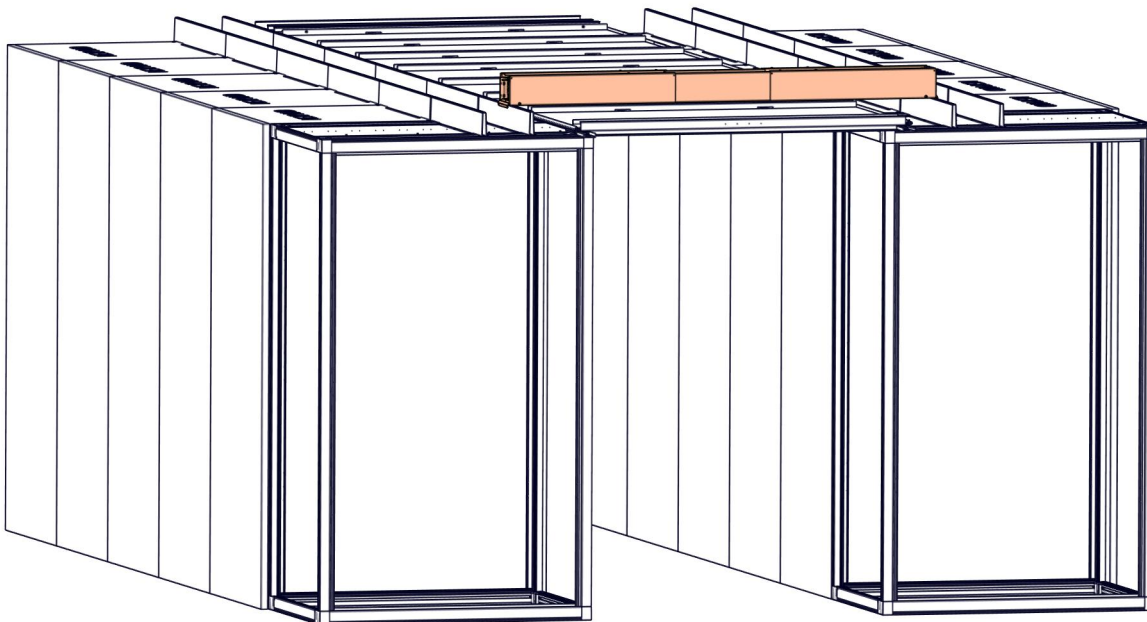

N-000105-0/001202-0

2.2

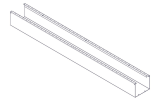
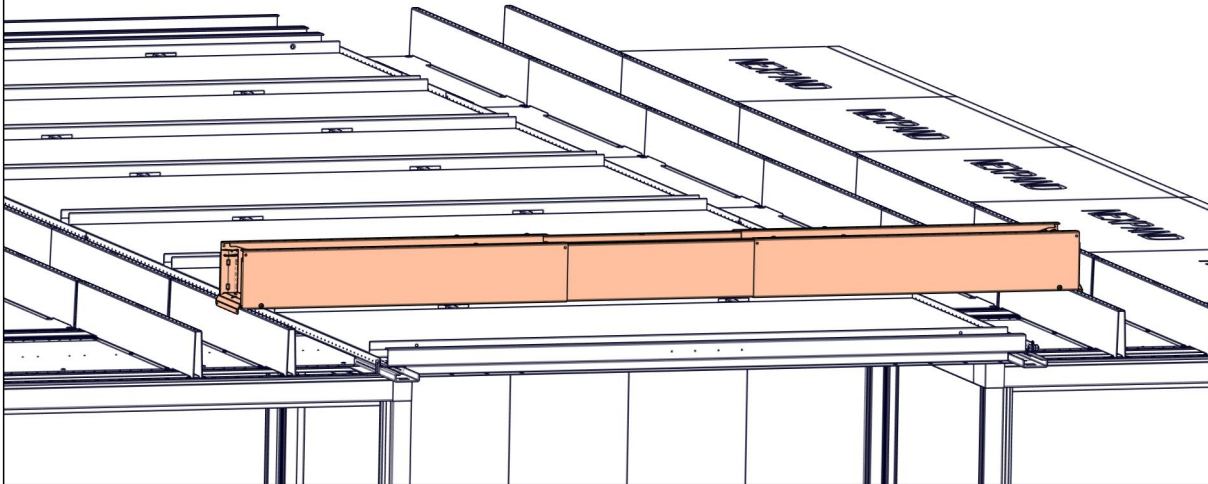
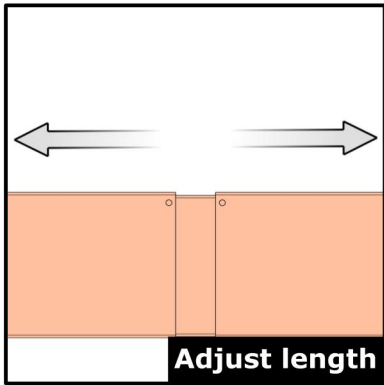

101HF

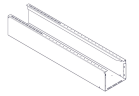

101HH

N-000105-0/001202-0

2.3

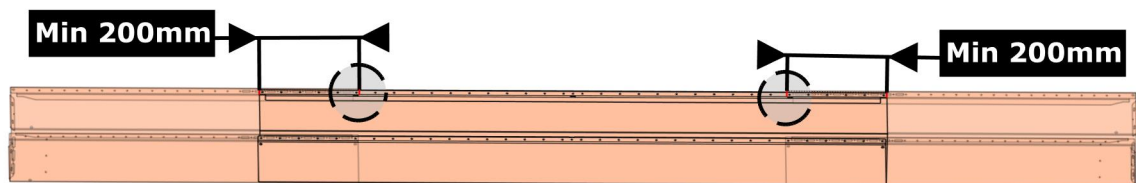
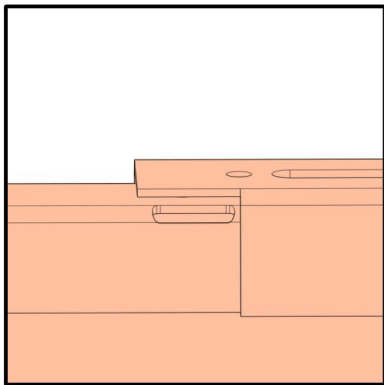

N-000105-0/001202-0

2.4

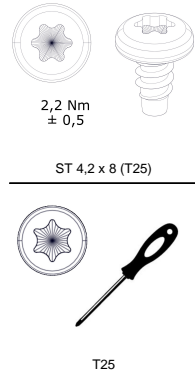
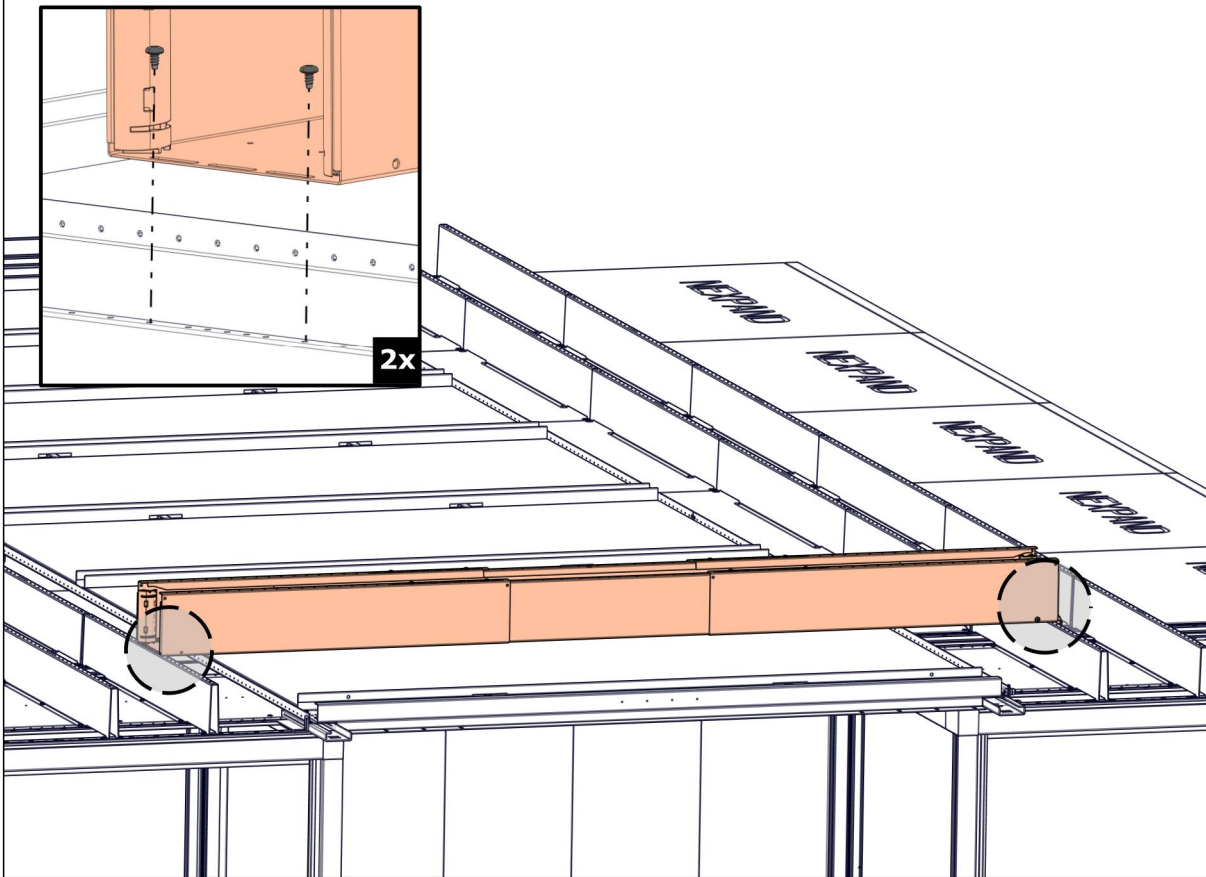

N-000105-0/001202-0

2.5

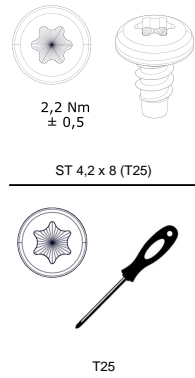
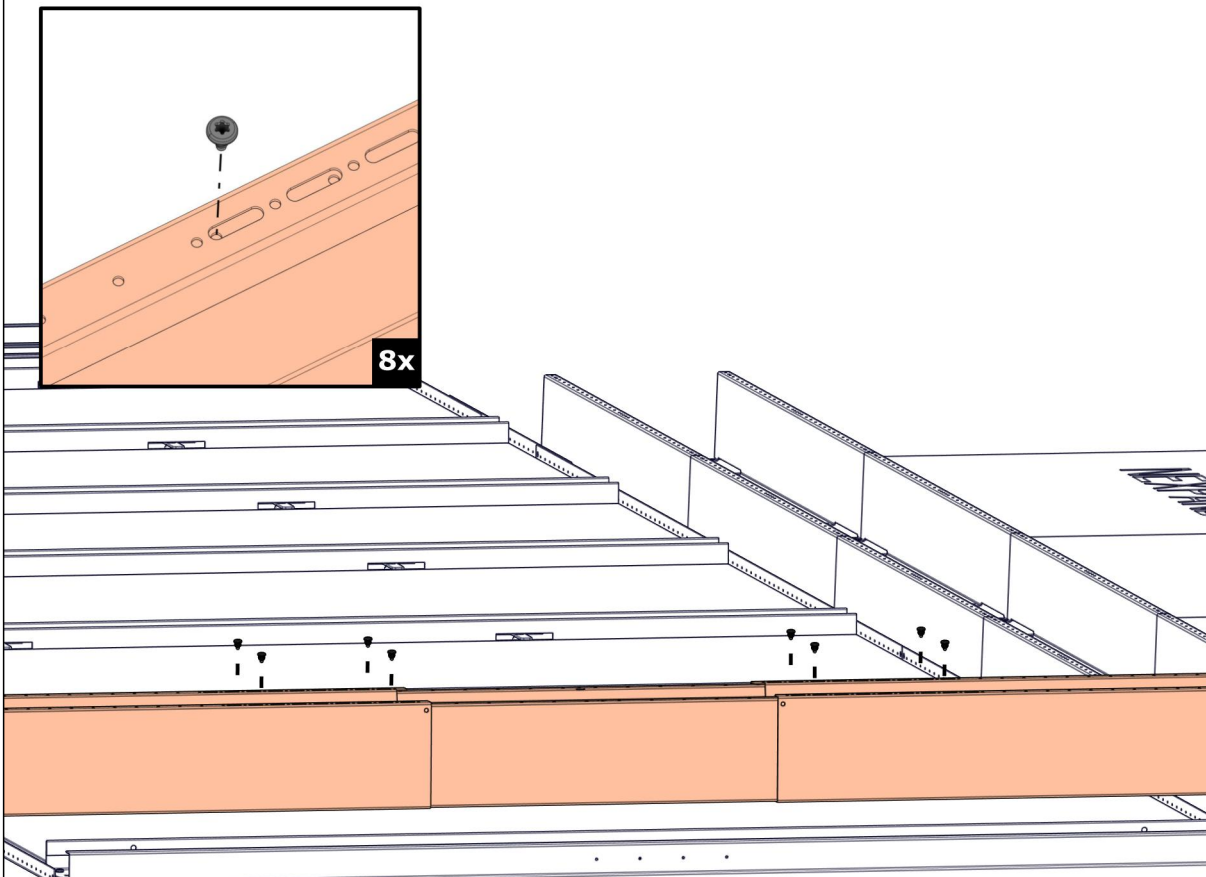

N-000105-0/001202-0

2.6

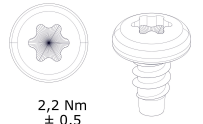
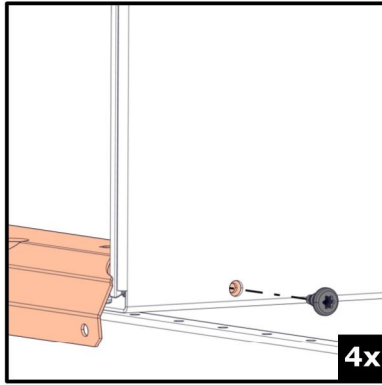
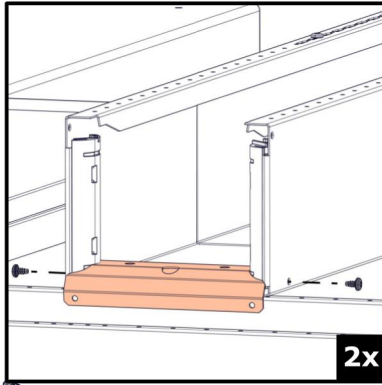
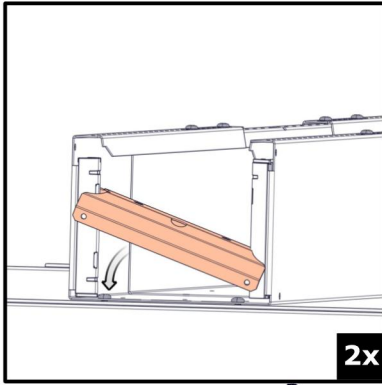

2,2 Nm
± 0,5

ST 4,2 x 8 (T25)

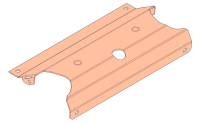

101HE



T25

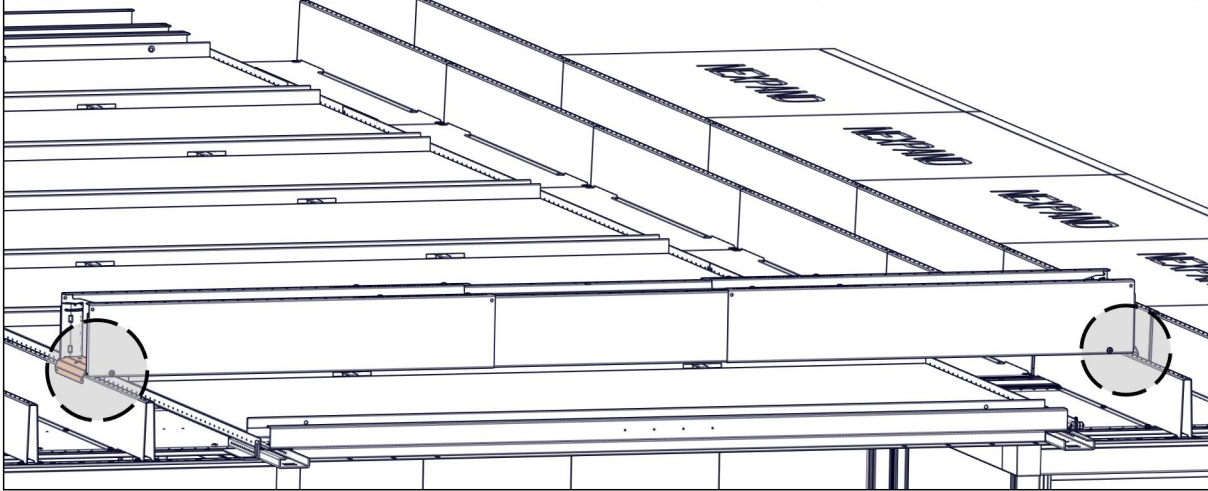

N-000105-0/001202-0

2.7

(this step intentionally left blank)

N-000105-0/001202-0

3.1

H100

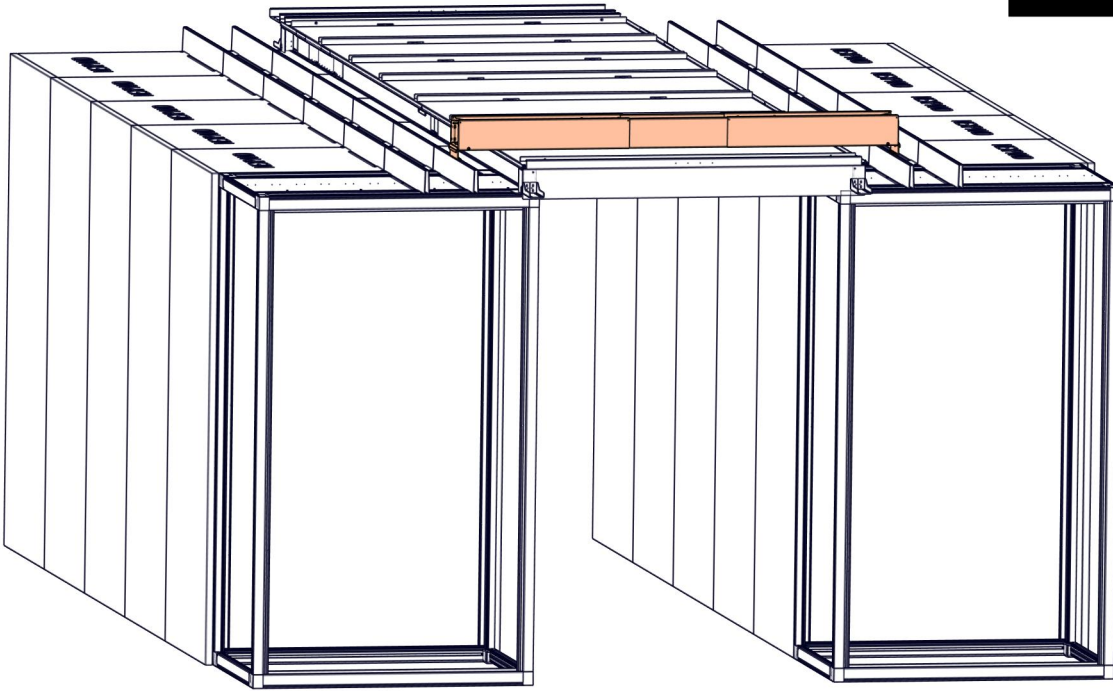

N-000105-0/001201-0

3.2

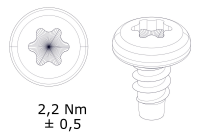
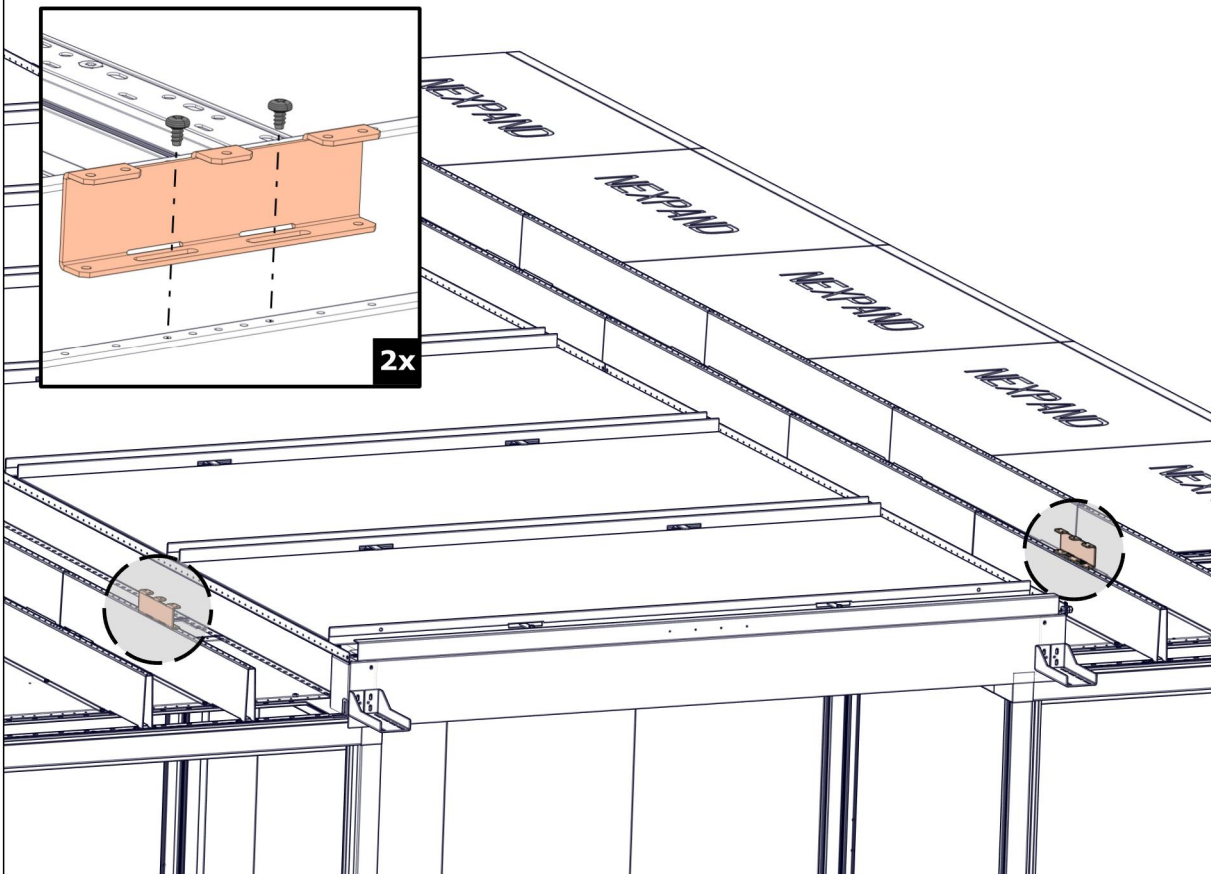

2,2 Nm
± 0,5

ST 4,2 x 8 (T25)

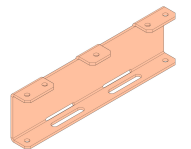

101HC



T25

N-000105-0/001201-0

3.3

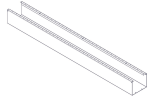
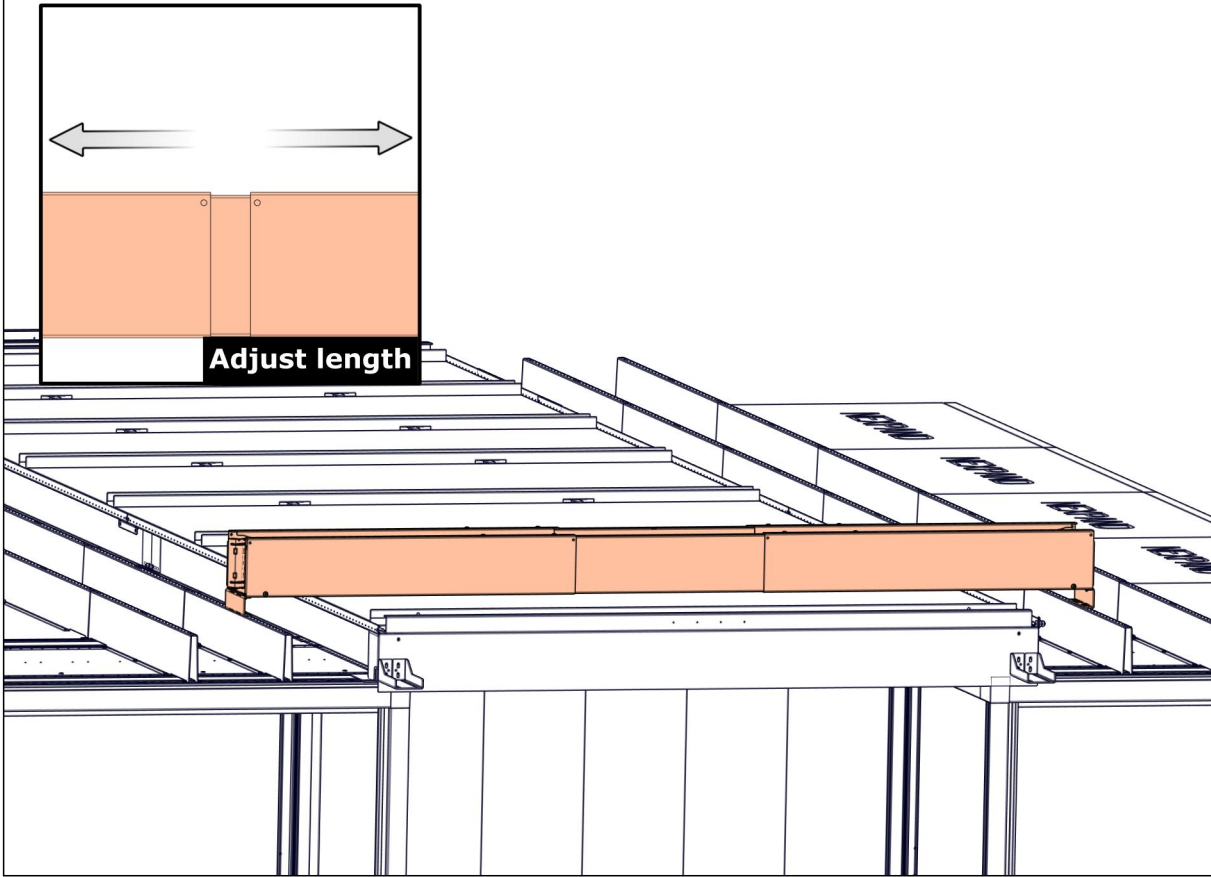

101HF

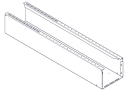

101HH

N-000105-0/001201-0

3.4

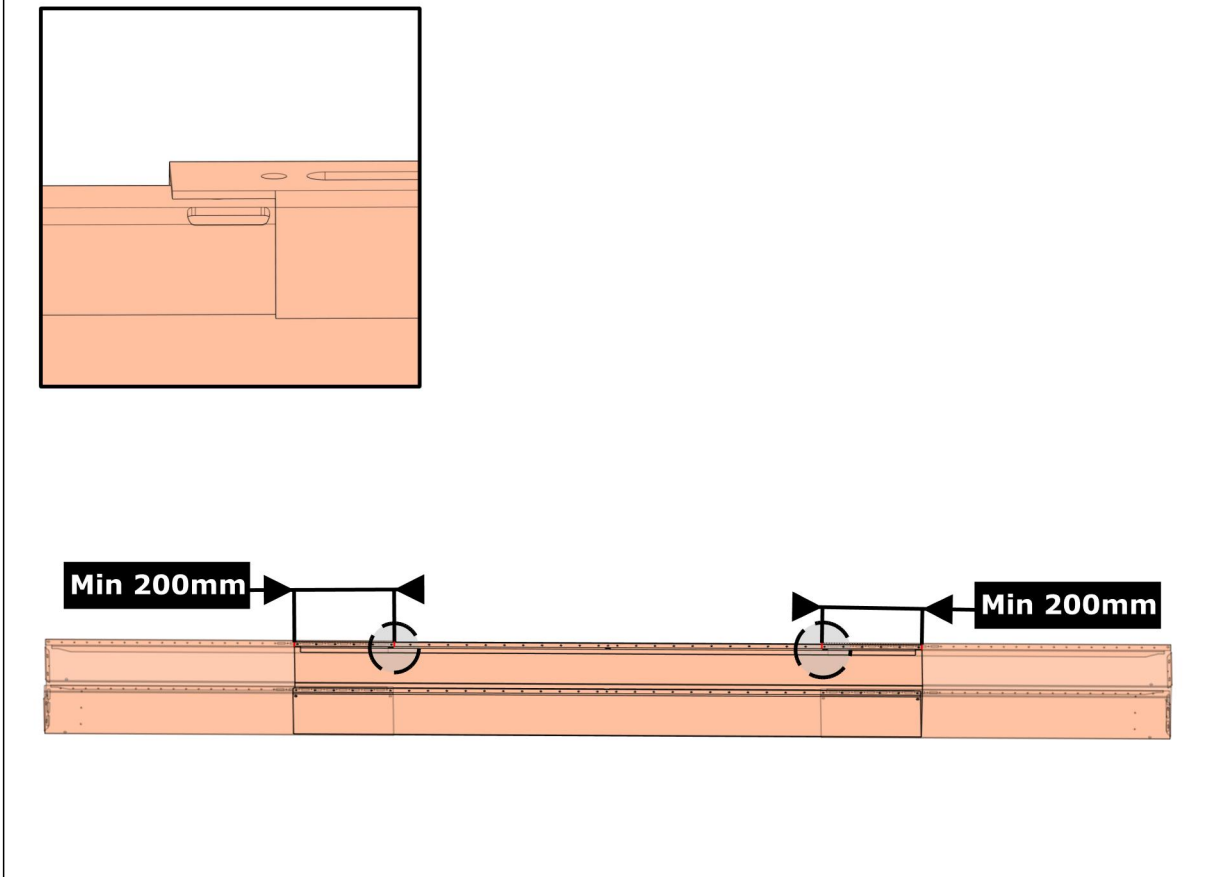

Min 200mm

Min 200mm

N-000105-0/001201-0

3.5

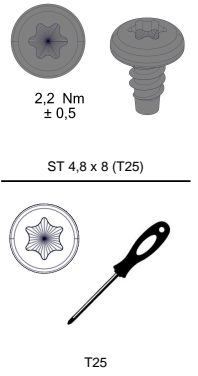
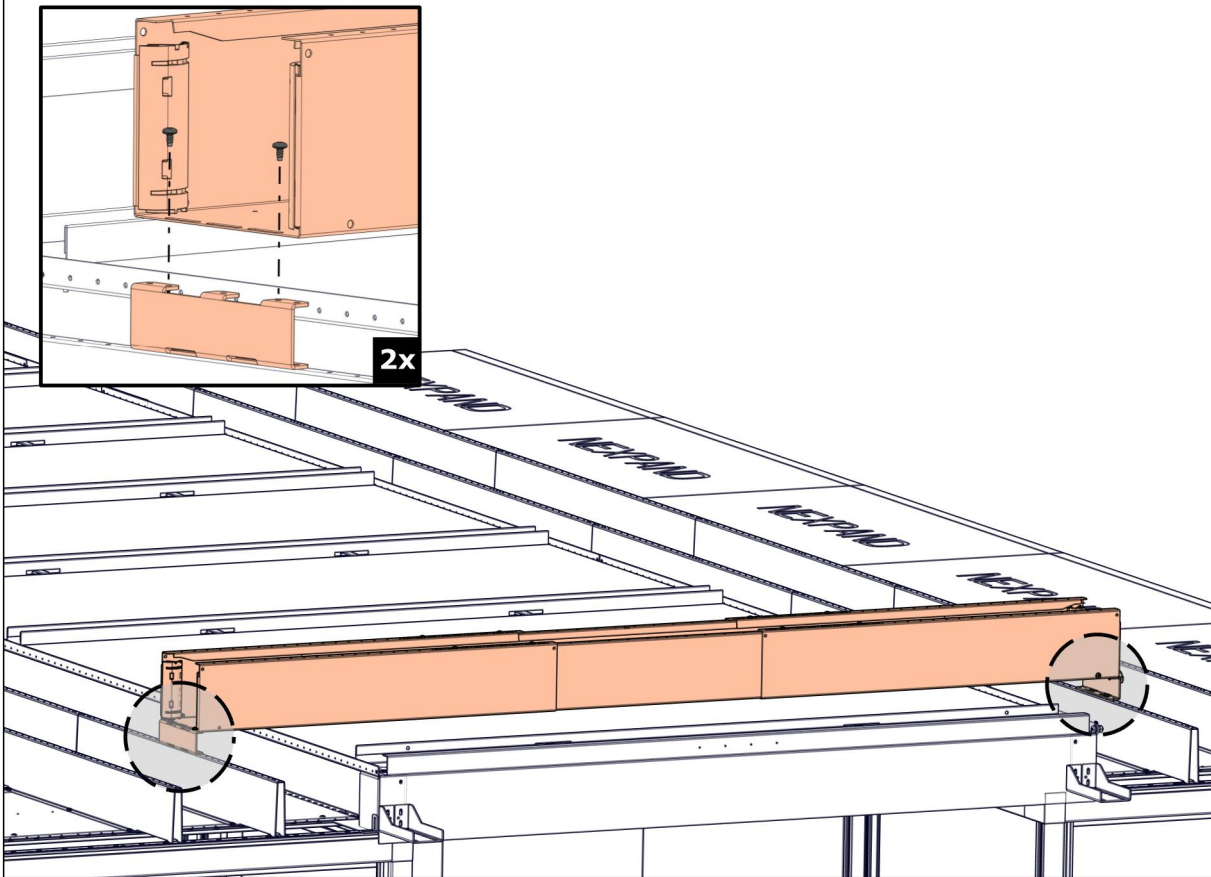

3.6

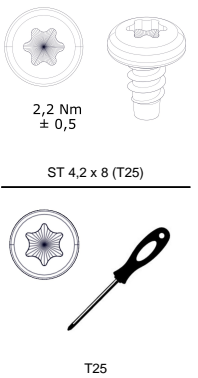
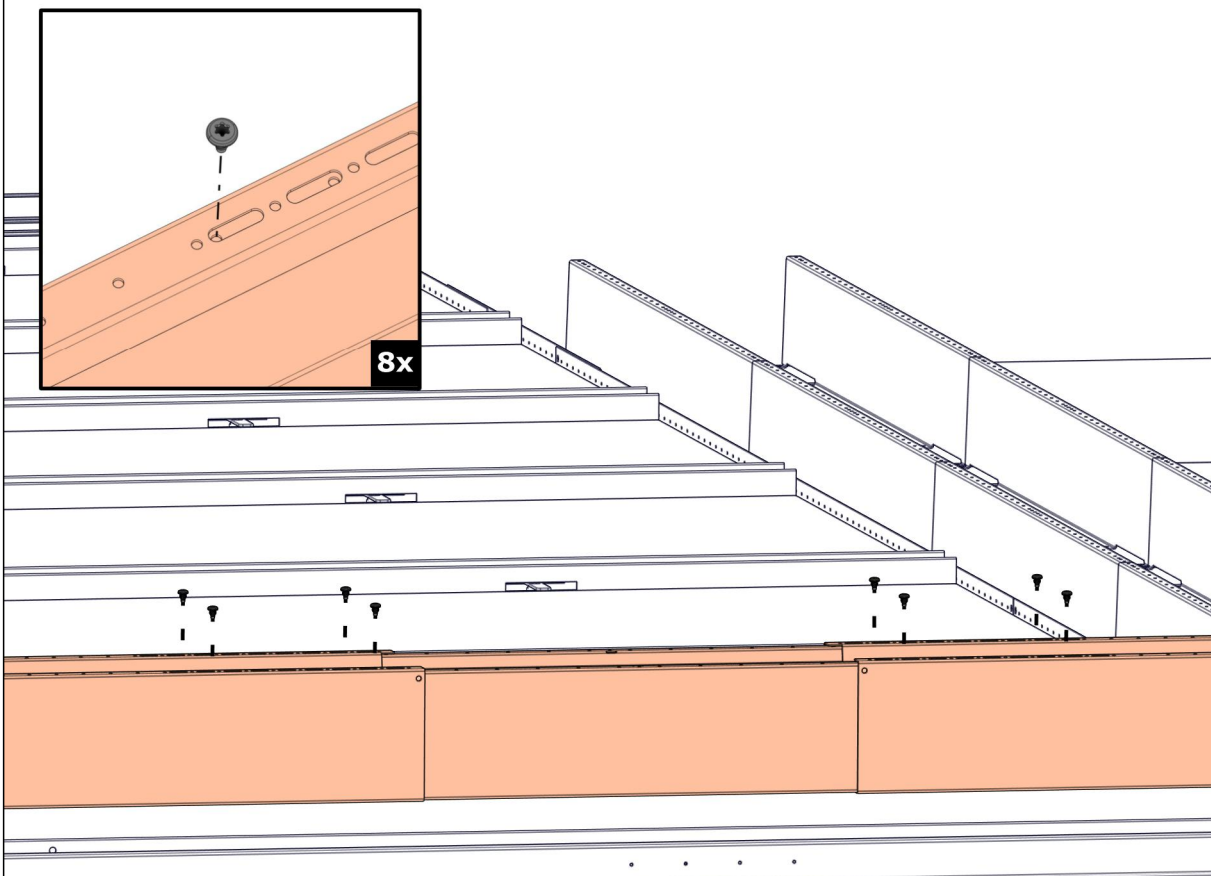

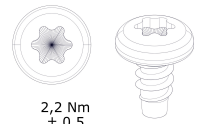
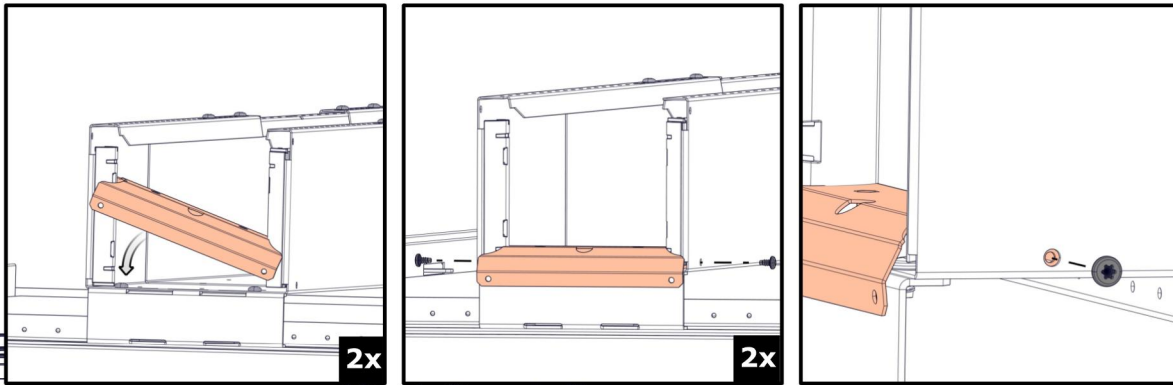

2,2 Nm
± 0,5

ST 4.2 x 8 (T25)

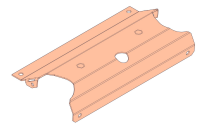

101HE

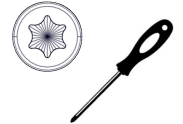

T25

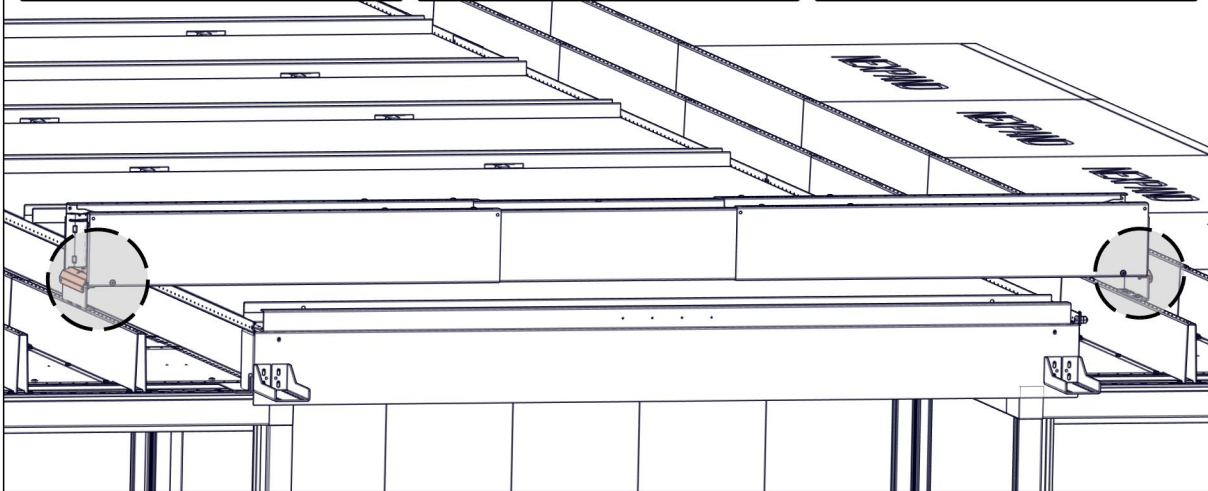

N-000105-0/001201-0



A brand of  **legrand**

Minkels Nederland

Eisenhowerweg 12

Postbus 28

5460 AA Veghel

Nederland

email: info@minkels.com

tel: +31 (0)413 311 100